

ASSEMBLY INSTRUCTION

KNOX

SINGLE BED

77566



Imported by JWA Furniture Pty Ltd, Qld, Brisbane Australia.
For any assistance with assembly or for missing parts please refer to your receipt

PRE-ASSEMBLY PREPARATION

Before you start:

1. Choose a clean, level, spacious assembly area. Avoid hard surfaces that may damage the product
2. Take care when lifting. Product should be assembled as near as possible to the point of use
3. Ensure that you have all required contents for complete assembly
4. Always read the assembly instructions carefully before beginning assembly.
5. Keep all hardware parts and packaging out of reach of small children.
6. Do not over tighten the screws and bolts as this may damage the threads
7. Assembly is to be carried out by a competent adult(s) ONLY
8. During assembly, children should be kept away from the product due to possible risk to injury.
9. Do not use this item if any components are missing or damaged.
10. Please keep the instructions for future reference.

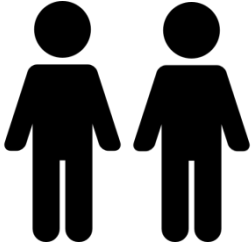
	
Allow 20 min	For 2 person

PARTS LIST

A M6x20mm bolts x 8pcs

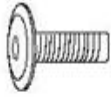

B M6x35mm bolts x 2pcs



C M4 Allen Key x 1pc
(used with M6 bolts)



1	Headboard x 1pc	5	Slat (905mm) x 13pcs
2	Footboard x 1pc	6	End Cap x 26pcs
3	Siderail x 2pcs	7	Metal Bulb x 4pcs
4	Cross Bar x 1pc		

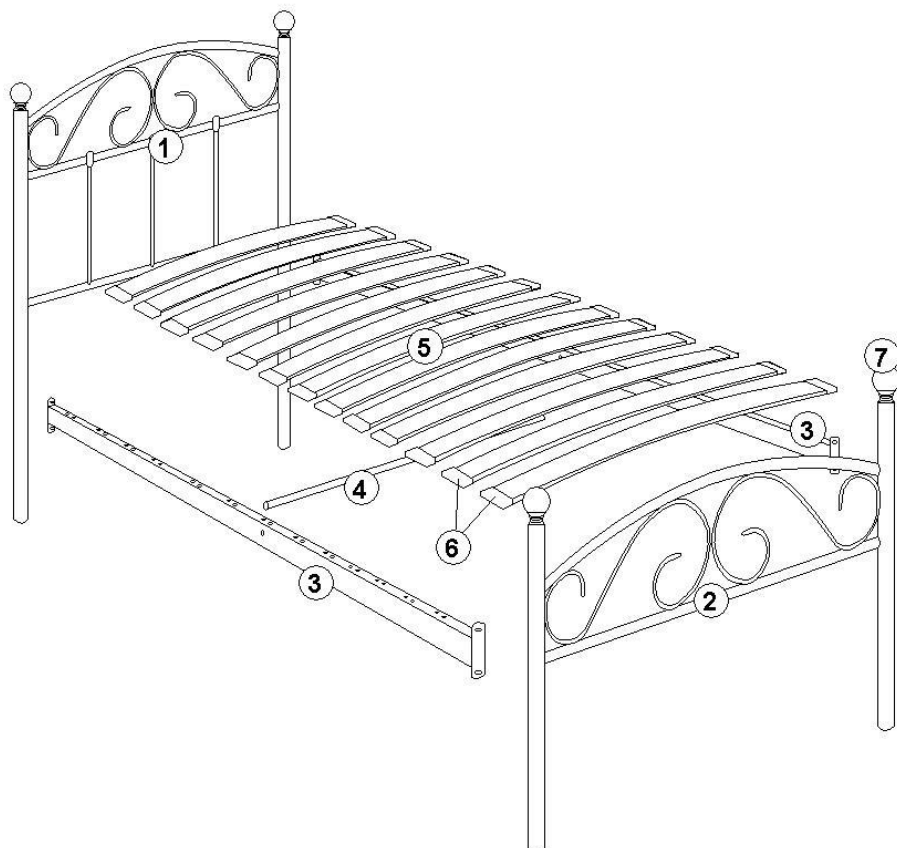

STEP 1:

- Prepare a protected surface with a blanket or cardboard.
- Connect a side rail(3) to the headboard and footboard. Secure with 2x bolt(A) per corner. Fasten with allen key(C).
- Repeat for the other side rail.
- Push the metal bulb(7) into the hole above the headboard and footboard.

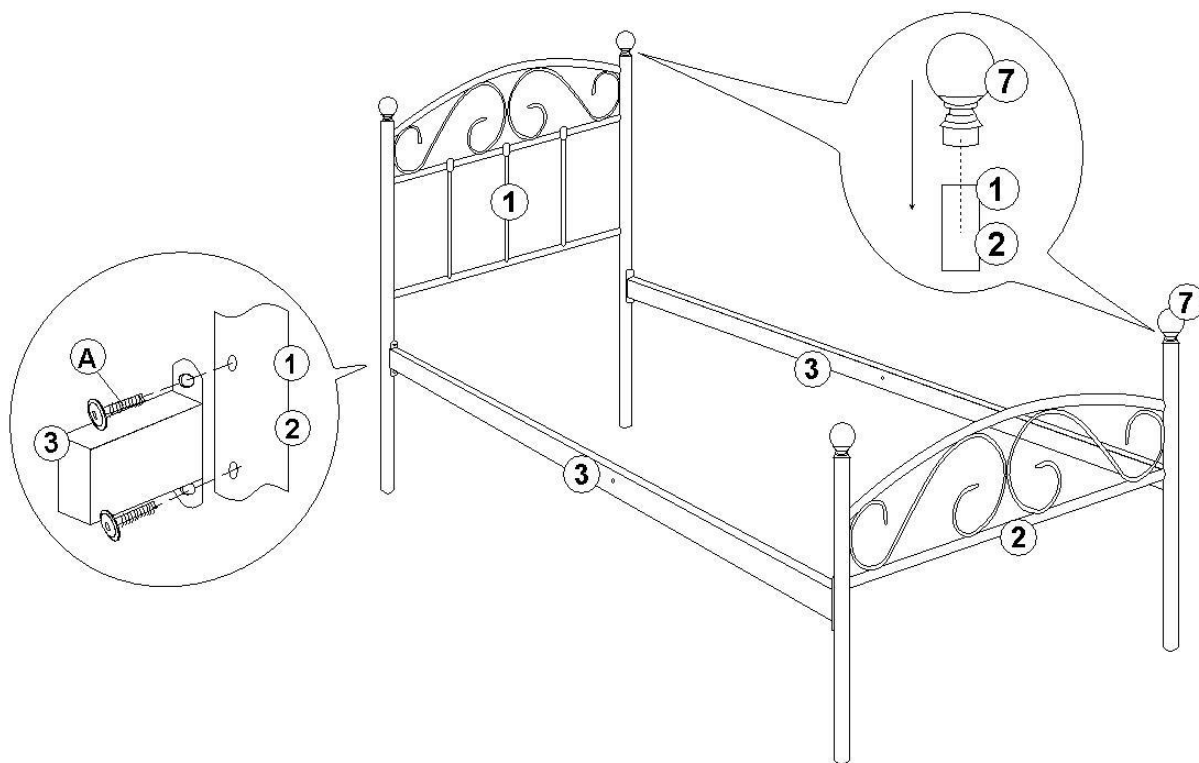

STEP 2:

- Attach the cross bars(4) to the side rail(3), as shown below. Use 2x bolt(B). Fasten with allen key(C).

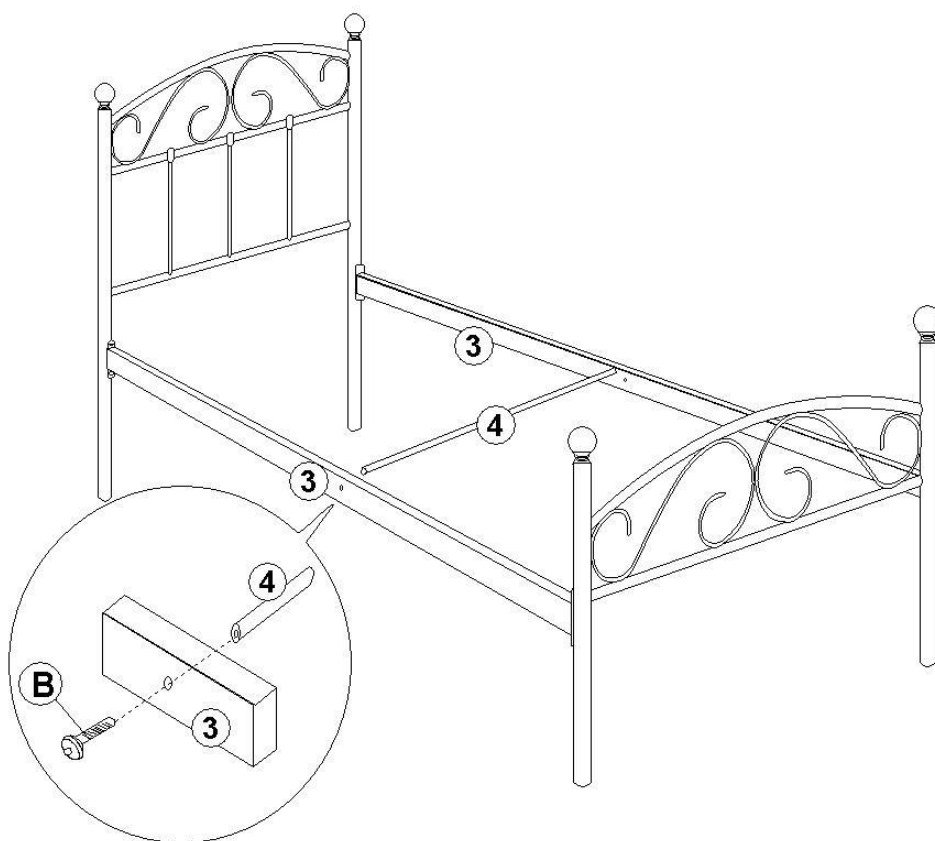

STEP 3:

- Attach an end cap(6) onto every slat, 2 per slat(5).
- Attach the slat to the bed as shown below. Push the caps into the holes.

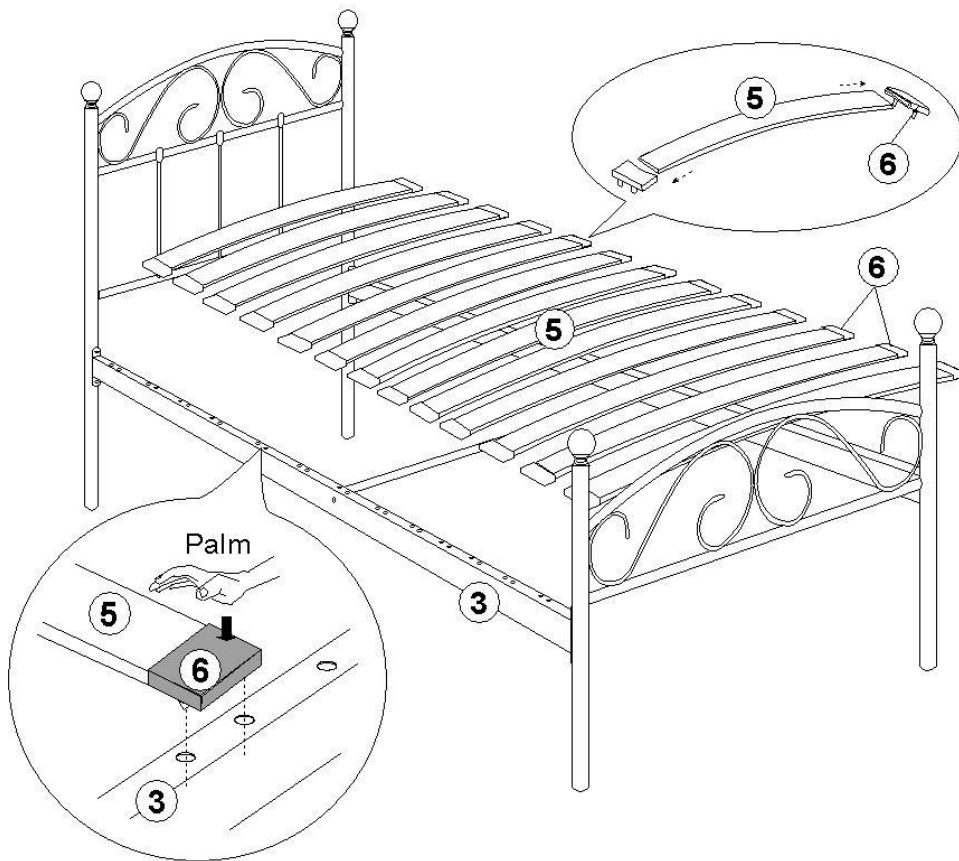

Assembly Is Complete



PRODUCT CARE:

FURNITURE / BED

- 1. When assembling your furniture / bed please ensure that you have checked the contents for all relevant parts.**
- 2. When tightening bolts make sure that they are fully tightened but not forced.**
- 3. When moving your fully assembled bed you must first remove the mattress and lift the frame into position, take care when lifting and always have two people handling the bed. PLEASE DO NOT DRAG THE BED as this will cause damage to the rail.**
- 4. It is advisable to use approved cleaning products when cleaning the furniture and bed frame as certain chemical based cleaners could have an adverse effect on the bed finish.**